

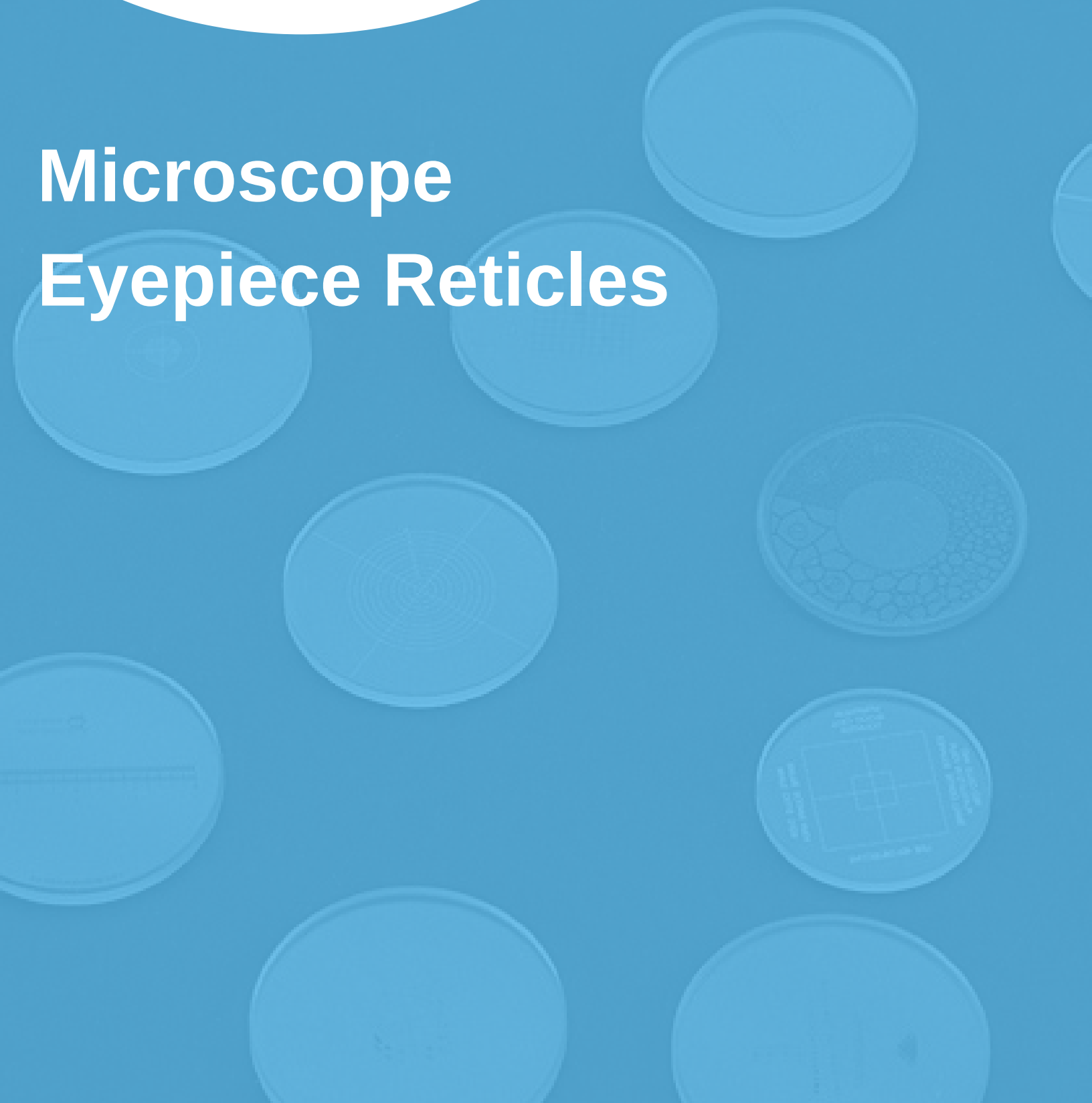

**GRATICULES
OPTICS**

Microscope Eyepiece Reticles



EYEPIECE RETICLES / GRATIQUES

Definition

An eyepiece reticle is a glass disc with a pattern on it that fits at the optical plane inside a microscope eyepiece. It is used to provide alignment, measurement, size or shape comparison, or area counting of specimens by having the reticle pattern superimposed over the specimen image. The terms reticle, graticule and reticule are all used to describe these items.

Standard Patterns

The following pages show the wide range of patterns that we have available. These include:

- Lines and cross-lines for alignment
- Scales and gauges for measurement
- Grids for counting and referencing
- Particle sizing to determine shape, size and quantity of materials or vapours
- Protractors for measuring angles
- Stereology for extracting quantitative information from 3D images
- Many specialist patterns designed by Scientists for specific applications

All Graticules Optics eyepiece reticles are produced on 1.5mm thick optical glass. The image, which is created using a vacuum evaporated chrome process, is correct reading through the glass. All eyepiece reticles are available in a variety of standard diameters to suit most microscopes in the marketplace. Other sizes are available to special order.

Custom Patterns

If you need something different from the patterns in this catalogue there is no problem, we have a very cost-effective custom reticle facility that is able to make the exact pattern you require.

Selecting your Reticle

There are two things that need to be defined when selecting your reticle:

1. The pattern that is suitable for your application
2. The diameter required to fit your eyepiece

The application or method that you are working to will normally determine the reticle pattern that will be required. For instance, if you are doing straightforward length measurements you may require a simple horizontal scale, if you are performing asbestos analysis you are most likely to need a Walton & Beckett reticle.

One very common mistake that is made when selecting the reticle is with the size of the pattern. If you have a 10mm length scale (such as our NE1) in the eyepiece this does not mean that it will be measure 10mm at the specimen stage. You have to take into account the objective magnification. Thus if you are using a 10x objective lens then the 10mm scale will represent 1mm at the specimen stage ($10\text{mm}/10\text{x} = 1\text{mm}$). In practical use, if you have a specimen of typically 50 micron (0.050mm) length and you are using a 40x objective then you will need to select a reticle pattern that has a scale range capable of measuring a size of 2mm ($0.050\text{mm} \times 40\text{x} = 2\text{mm}$).

The reticle is fitted inside the eyepiece at the optical plane. The optical plane being the position where both the formed images of the specimen and the reticle are in focus. The reticle diameter needs to be a fraction smaller than the inside diameter of the eyepiece at the point of the optical plane. Most modern eyepieces have a reticle holder or threaded bush to secure the reticle in the correct position. If there is no fixing device in the eyepiece then Graticules Optics offer a measuring and fitting service.

Measuring and Fitting Service

When fitting reticles it is essential this is done in clean areas, any speck of dust on the reticle will be visible when installed in the microscope. The locating and securing of the reticle can also cause problems. Due to these difficulties and the uncertainty that many people have about sizing a reticle, Graticules Optics offer a measuring and fitting service.

Customers send us their eyepiece and we carry out the following actions:

1. Check to see if fitting a reticle is feasible and then measure the internal dimensions to determine the diameter required.
2. Provide a quotation for the supply and fitting of the reticle.
3. Once order/payment has been received Graticules Optics will make and fit the reticle then despatch it back to you.

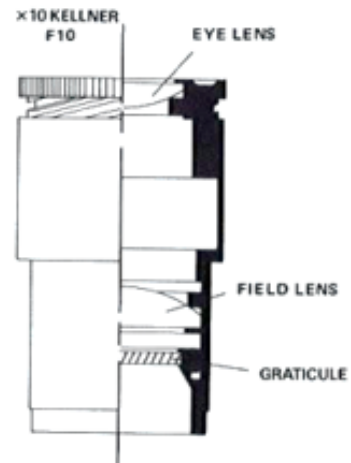
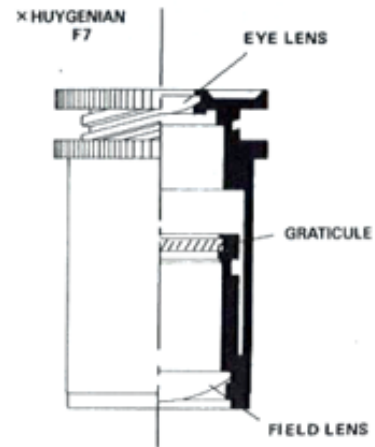

Lines and Crosses

Single Lines

NE50

For measurement of large objects in conjunction with graduated mechanical stage, and for alignment. Image covers entire field of view

Pattern	Description	Diameter	Order Code
NE50	Single line, nominal width 0.02mm.	16mm	01B16238
		19mm	01B19238
		20.4mm	01B20.4238
		21mm	01B21238
		23mm	01B23238
		24mm	01B24238
		24.5mm	01B24.5238
		25mm	01B25238
		26mm	01B26238
		27mm	01B27238
		Special	01BSP238

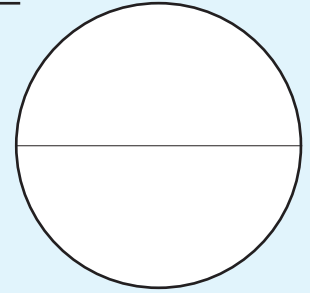

Crosslines

NE8, NE81, NE82

Used as for NE50 but for measurements in two directions and for sighting and alignment. Image covers entire field of view

Pattern	Description	Diameter	Order Code
NE8	Crosslines, nominal line width 0.02mm.	16mm	01B16206
		19mm	01B19206
		20.4mm	01B20.4206
		21mm	01B21206
		23mm	01B23206
		24mm	01B24206
		24.5mm	01B24.5206
		25mm	01B25206
		26mm	01B26206
		27mm	01B27206
		Special	01BSP206

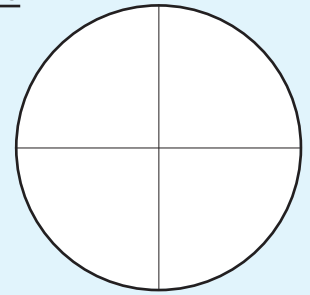

Pattern	Description	Diameter	Order Code
NE81	Crosslines, nominal line width 0.04mm	16mm	01B16234
		19mm	01B19234
		20.4mm	01B20.4234
		21mm	01B21234
		23mm	01B23234
		24mm	01B24234
		24.5mm	01B24.5234
		25mm	01B25234
		26mm	01B26234
		27mm	01B27234
		Special	01BSP234

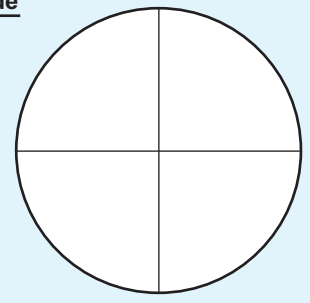

Pattern	Description	Diameter	Order Code
NE82	Crosslines, nominal line width 0.005mm	16 mm	01B16235
		19mm	01B19235
		20.4mm	01B20.4235
		21mm	01B21235
		23mm	01B23235
		24mm	01B24235
		24.5mm	01B24.5235
		25mm	01B25235
		26mm	01B26235
		27mm	01B27235
		Special	01BSP235

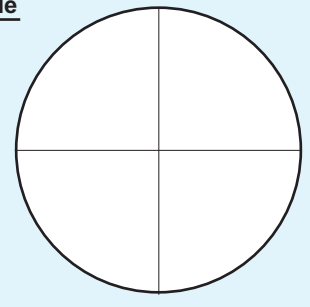

Broken Crosslines

NE56

Use as crossed lines. Broken lines enable fine detail to be seen at the breaks. A thin boundary would be lost behind a continuous line. Image covers entire field of view.

Pattern	Description	Diameter	Order Code
NE56	Broken crossline.	16mm	01B16231
		19mm	01B19231
		20.4mm	01B20.4231
		21mm	01B21231
		23mm	01B23231
		24mm	01B24231
		24.5mm	01B24.5231
		25mm	01B25231
		26mm	01B26231
		27mm	01B27231
		Special	01BSP231

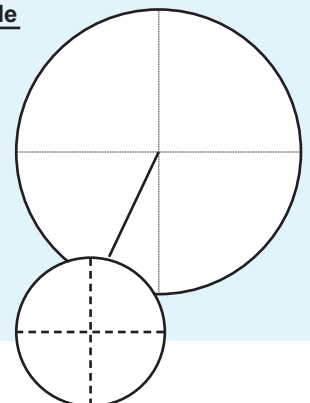

Crossed Gauge Lines

NE53, NE54

Use as crossed lines, but for measuring distances between lines. Greater accuracy can be obtained by locating the specimen detail between the reticle gauge pair. Image covers entire field of view.

Pattern	Description	Diameter	Order Code
NE53	Two vertical lines 0.1mm apart with horizontal line.	16mm	01B16230
		19mm	01B19230
		20.4mm	01B20.4230
		21mm	01B21230
		23mm	01B23230
		24mm	01B24230
		24.5mm	01B24.5230
		25mm	01B25230
		26mm	01B26230
		27mm	01B27230
	Special	01BSP230	

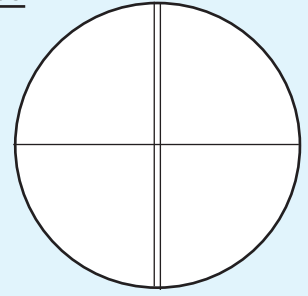

Pattern	Description	Diameter	Order Code
NE54	Two vertical lines 0.2mm apart.	16mm	01B16239
		19mm	01B19239
		20.4mm	01B20.4239
		21mm	01B21239
		23mm	01B23239
		24mm	01B24239
		24.5mm	01B24.5239
		25mm	01B25239
		26mm	01B26239
		27mm	01B27239
	Special	01BSP239	

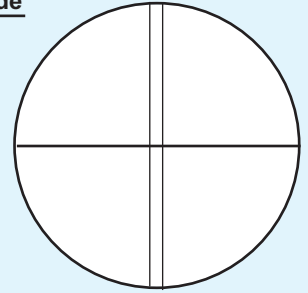

Eyepiece Scales

Horizontal & Vertical Scales

NE1, NE2, NE5, NE20 NE28, NE31, NE41, NE120

Used for measuring lengths of specimen or distances between points on a variety of different shaped objects.

Pattern	Description	Diameter	Order Code
NE120	Horizontal micrometer 20mm long with 200 divisions of 0.1mm.	23mm	01B23320
		24mm	01B24320
		24.5mm	01B24.5320
		25mm	01B25320
		26mm	01B26320
		27mm	01B27320
	Special	01BSP320	

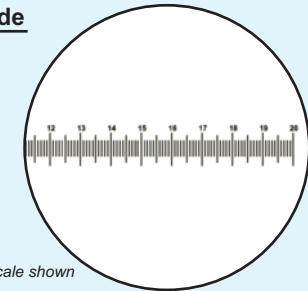

NE1 Scale: This eyepiece reticle has an overall length of 10.00mm with 100 subdivisions of 0.1mm. When used with a x10 objective each division will represent 10 microns on the specimen. By dividing the division of the chosen reticle by the magnification of the objective one obtains an approximate value that each division will represent on the stage.

Pattern	Description	Diameter	Order Code
NE1	Horizontal micrometer 10mm long with 100 divisions of 0.1mm.	16mm	01B16201
		19mm	01B19201
		20mm	01B20201
		20.4mm	01B20.4201
		21mm	01B21201
		23mm	01B23201
		24mm	01B24201
		24.5mm	01B24.5201
		25mm	01B25201
		26mm	01B26201
27mm	01B27201		
	Special	01BSP201	

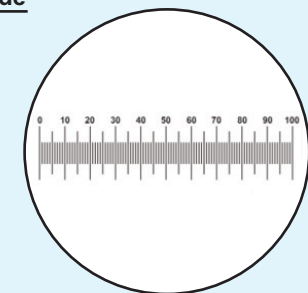

Pattern	Description	Diameter	Order Code
NE2	Vertical micrometer 10mm long with 100 divisions of 0.1mm.	16mm	01B16202
		19mm	01B19202
		20mm	01B20202
		20.4mm	01B20.4202
		21mm	01B21202
		23mm	01B23202
		24mm	01B24202
		24.5mm	01B24.5202
		25mm	01B25202
		26mm	01B26202
27mm	01B27202		
	Special	01BSP202	

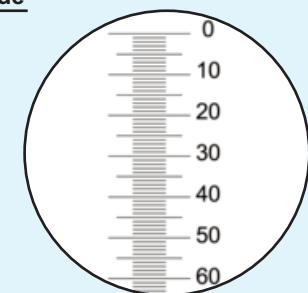

Eyepiece Scales

Horizontal & Vertical Scales

Used for measuring lengths of specimen or distances between points on a variety of different shaped objects.

Pattern	Description	Diameter	Order Code
---------	-------------	----------	------------

NE5	Horizontal micrometer 5mm long with 100 divisions of 0.05mm.	16mm	01B16203
		19mm	01B19203
		20.4mm	01B20.4203
		21mm	01B21203
		23mm	01B23203
		24mm	01B24203
		24.5mm	01B24.5203
		25mm	01B25203
		26mm	01B26203
		27mm	01B27203
		Special	01BSP203

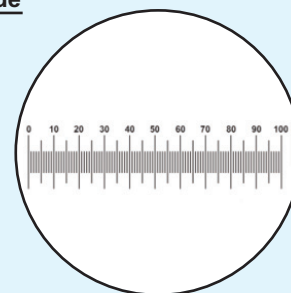

Pattern	Description	Diameter	Order Code
---------	-------------	----------	------------

NE28	Horizontal scale 1mm long, with 100 divisions of 0.01mm.	16mm	01B16217
		19mm	01B19217
		20.4mm	01B20.4217
		21mm	01B21217
		23mm	01B23217
		24mm	01B24217
		24.5mm	01B24.5217
		25mm	01B25217
		26mm	01B26217
		27mm	01B27217
		Special	01BSP217

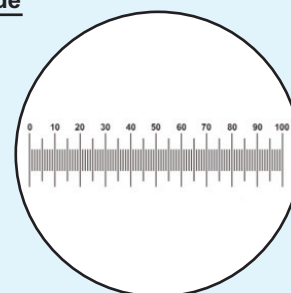

Pattern	Description	Diameter	Order Code
---------	-------------	----------	------------

NE41	Horizontal scale 10mm long with 200 divisions of 0.05mm.	16mm	01B16223
		19mm	01B19223
		20.4mm	01B20.4223
		21mm	01B21223
		23mm	01B23223
		24mm	01B24223
		24.5mm	01B24.5223
		25mm	01B25223
		26mm	01B26223
		27mm	01B27223
		Special	01BSP223

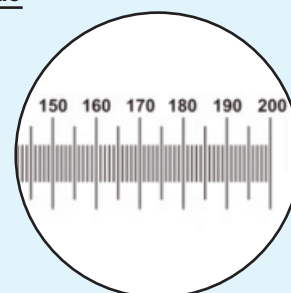

Part scale shown

Pattern	Description	Diameter	Order Code
---------	-------------	----------	------------

NE20	Horizontal scale 0.1" long with 100 divisions of 0.001".	16mm	01B16214
		19mm	01B19214
		20.4mm	01B20.4214
		21mm	01B21214
		23mm	01B23214
		24mm	01B24214
		24.5mm	01B24.5214
		25mm	01B25214
		26mm	01B26214
		27mm	01B27214
		Special	01BSP214

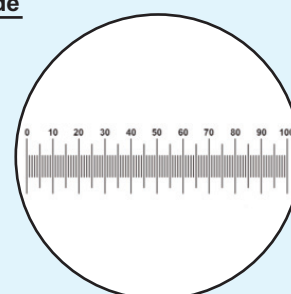

Pattern	Description	Diameter	Order Code
---------	-------------	----------	------------

NE31	Horizontal scale 0.5" long with 100 divisions of 0.005".	16mm	01B16219
		19mm	01B19219
		20.4mm	01B20.4219
		21mm	01B21219
		23mm	01B23219
		24mm	01B24219
		24.5mm	01B24.5219
		25mm	01B25219
		26mm	01B26219
		27mm	01B27219
		Special	01BSP219

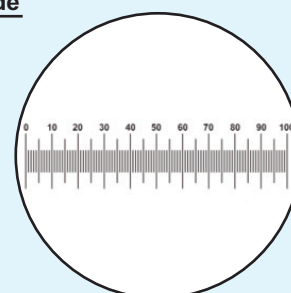

Eyepiece Scales

Crossed Scales

NE17, NE18

Used as horizontal and vertical scales, and especially useful when interested in measurements in different axis

Pattern	Description	Diameter	Order Code
NE17	Crossed micrometer scales. Each 10mm long with 100 divisions of 0.1mm.	16mm	01B16212
		19mm	01B19212
		20.4mm	01B20.4212
		21mm	01B21212
		23mm	01B23212
		24mm	01B24212
		24.5mm	01B24.5212
		25mm	01B25212
		26mm	01B26212
		27mm	01B27212
	Special	01BSP212	

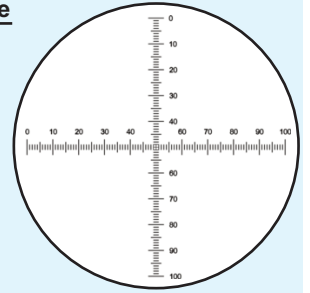

Pattern	Description	Diameter	Order Code
NE18	Crossed micrometer scales. Each 5mm long with 100 divisions of 0.05mm.	16mm	01B16213
		19mm	01B19213
		20.4mm	01B20.4213
		21mm	01B21213
		23mm	01B23213
		24mm	01B24213
		24.5mm	01B24.5213
		25mm	01B25213
		26mm	01B26213
		27mm	01B27213
	Special	01BSP213	

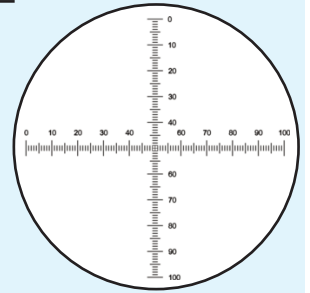

NE72 NEW

Pattern	Description	Diameter	Order Code
NE72	Crossed micrometer scales. Each 20mm long with 200 divisions of 0.1mm.	23mm	01B23303
		24mm	01B24303
		24.5mm	01B24.5303
		25mm	01B25303
		26mm	01B26303
		27mm	01B27303
		Special	01BSP303

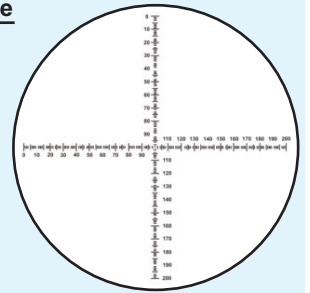

NE70 NEW

Pattern	Description	Diameter	Order Code
NE70	Crossed micrometer scales. (imperial). Each 0.8" long with 400 divisions of 0.002".	21mm	01B21301
		23mm	01B23301
		24mm	01B24301
		24.5mm	01B24.5301
		25mm	01B25301
		26mm	01B26301
		27mm	01B27301
Special	01BSP301		

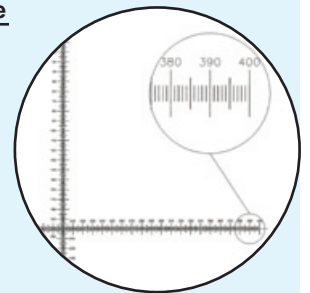

Part scale shown

Scales with Crosslines

NE7

The inclusion of a crossline assists in ensuring alignment of the reticle with edges, etc, in the specimen.

Pattern	Description	Diameter	Order Code
NE7	Horizontal micrometer scale 10mm long, with 100 divisions of 0.1mm and crosslines	16mm	01B16204
		19mm	01B19204
		20.4mm	01B20.4204
		21mm	01B21204
		23mm	01B23204
		24mm	01B24204
		24.5mm	01B24.5204
		25mm	01B25204
		26mm	01B26204
		27mm	01B27204
	Special	01BSP204	

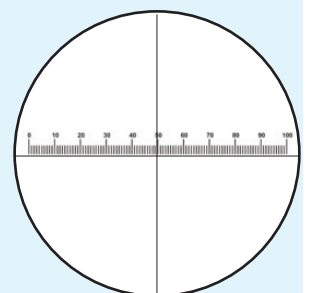

Drawings not to scale

Scales with Crosslines

NE7N, NE77, NE777

The inclusion of a crossline assists in ensuring alignment of the reticle with edges, etc, in the specimen.

Pattern	Description	Diameter	Order Code
NE7N	Horizontal micrometer scale 10mm long with 100 divisions of 0.1mm, includes crosslines and additional 10mm square.	16 mm	01B16205
		19mm	01B19205
		20.4mm	01B20.4205
		21mm	01B21205
		23mm	01B23205
		24mm	01B24205
		24.5mm	01B24.5205
		25mm	01B25205
		26mm	01B26205
		27mm	01B27205
	Special	01BSP205	

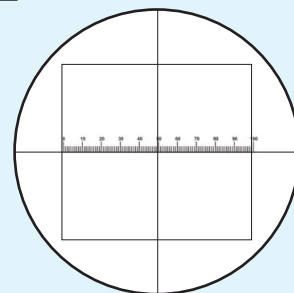

Pattern	Description	Diameter	Order Code
NE77	Horizontal micrometer scale 5mm long with 100 divisions of 0.05mm and crosslines.	16mm	01B16233
		19mm	01B19233
		20.4mm	01B20.4233
		21mm	01B21233
		23mm	01B23233
		24mm	01B24233
		24.5mm	01B24.5233
		25mm	01B25233
		26mm	01B26233
		27mm	01B27233
	Special	01BSP233	

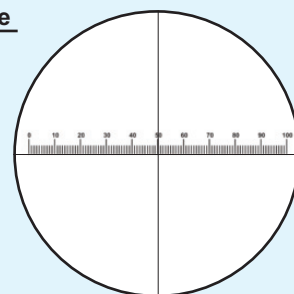

Pattern	Description	Diameter	Order Code
NE777	Horizontal micrometer scale 0.5" long with divisions of 0.005" and crosslines.	16mm	01B16237
		19mm	01B19237
		20.4mm	01B20.4237
		21mm	01B21237
		23mm	01B23237
		24mm	01B24237
		24.5mm	01B24.5237
		25mm	01B25237
		26mm	01B26237
		27mm	01B27237
	Special	01BSP237	

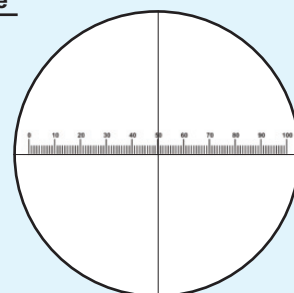

Squares and Grids

Note: These may need to be calibrated, according to intended use. There are a number of uses for the grids and squares listed and they will largely depend on the individual user's application.

Sectoring

A squared reticle might be used for the systematic examination of a specimen. Some of the squared patterns are numbered to aid the identification of areas of interest. Sectoring is particularly useful for making drawings of specimens onto graph paper. The chessboard type of pattern helps the user to distinguish the position being examined: the darker squares are translucent, while the lighter ones are transparent, avoiding eyestrain in prolonged counting as may be necessary in haematology. These patterns provide the same advantages when used with image analysis and capture devices.

Counting

A squared reticle can be used for counting. Here the basic principle is that a small area of the specimen is analysed in order to obtain information about the total area. This minimises sometimes wasteful work enabling simple analysis of a particular area. An example of this would be the comparison of large to small particles in a specimen. By using the Miller reticle (NE57) only the smaller particles in the small square are counted, the result being multiplied by ten for comparison with the number of larger particles in the large square.

Squared Grids

Squared grids can be used in particle size analysis as simple technical aids where sophisticated image analysis systems are not required. The areas of the particles to be measured can be estimated by simply counting the number of squares occupied by those particles. It is necessary to estimate fractions of a square or make a rule (e.g. count as a square all partly covered squares at the right and bottom sides of the grid, and ignore partly covered squares at the left and upper sides of the square). This method would only be useful for a fairly crude estimation of a large diameter. For more detailed optical analysis it is advisable to use a specialised reticle such as those in the Particle Size Analysis section on page 11

Squared Grids

NE10, NE11, NE34

Simple grids are convenient for making sketches of the observed specimen. They are also useful for particle counting.

Pattern	Description	Diameter	Order Code
NE10	Grid (net) 0.5mm pitch.	16mm	01B16207
		19mm	01B19207
		20.4mm	01B20.4207
		21mm	01B21207
		23mm	01B23207
		24mm	01B24207
		24.5mm	01B24.5207
		25mm	01B25207
		26mm	01B26207
		27mm	01B27207
		Special	01BSP207

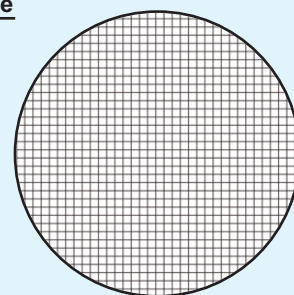

Pattern	Description	Diameter	Order Code
NE11	Grid (net) 1.0mm pitch.	16mm	01B16209
		19mm	01B19209
		20.4mm	01B20.4209
		21mm	01B21209
		23mm	01B23209
		24mm	01B24209
		24.5mm	01B24.5209
		25mm	01B25209
		26mm	01B26209
		27mm	01B27209
		Special	01BSP209

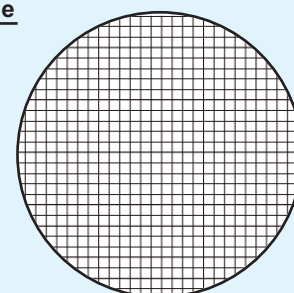

Pattern	Description	Diameter	Order Code
NE34	Grid (net) 0.1mm squares	16mm	01B16300
		19mm	01B19300
		20.4mm	01B20.4300
		21mm	01B21300
		23mm	01B23300
		24mm	01B24300
		24.5mm	01B24.5300
		25mm	01B25300
		26mm	01B26300
		27mm	01B27300
		Special	01BSP300

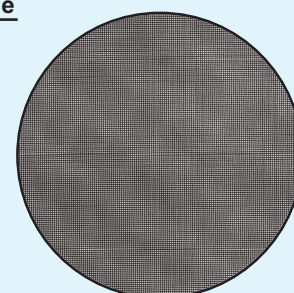

Indexed Grids

NE10A, NE11A

Useful for particle counting, particularly where reference is needed between workers. Also useful for area of specimen determinations.

Pattern	Description	Diameter	Order Code
NE10A	Numbered grid 5mm x 5mm. 0.5mm pitch. Marked 1–10 and A–J.	16mm	01B16208
		19mm	01B19208
		20.4mm	01B20.4208
		21mm	01B21208
		23mm	01B23208
		24mm	01B24208
		24.5mm	01B24.5208
		25mm	01B25208
		26mm	01B26208
		27mm	01B27208
		Special	01BSP208

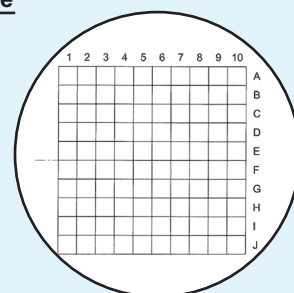

Pattern	Description	Diameter	Order Code
NE11A	Numbered grid 10mm x 10mm. 1.0mm pitch. Marked 1-10 and A-J.	16mm	01B16210
		19mm	01B19210
		20.4mm	01B20.4210
		21mm	01B21210
		23mm	01B23210
		24mm	01B24210
		24.5mm	01B24.5210
		25mm	01B25210
		26mm	01B26210
		27mm	01B27210
		Special	01BSP210

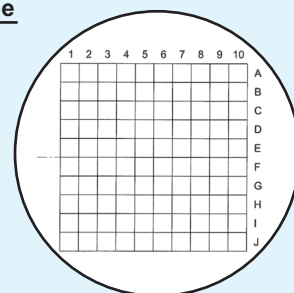

Indexed Grids

NE34A, NE71

Pattern	Description	Diameter	Order Code
NE34A	Numbered grid 1mm x 1mm. 0.1mm pitch. Marked 1-10 and A-J.	16mm	01B16220
		19mm	01B19220
		20.4mm	01B20.4220
		21mm	01B21220
		23mm	01B23220
		24mm	01B24220
		24.5mm	01B24.5220
		25mm	01B25220
		26mm	01B26220
		27mm	01B27220
		Special	01BSP220

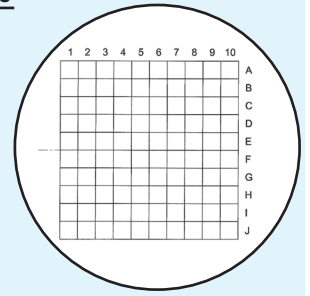

Pattern	Description	Diameter	Order Code
NE71	Index pattern	21 mm	01B21302
NEW	20 x 20 grid of 0.5mm squares	23mm	01B23302
		24mm	01B24302
		24.5mm	01B24.5302
		25mm	01B25302
		26mm	01B26302
		27mm	01B27302
		Special	01BSP302

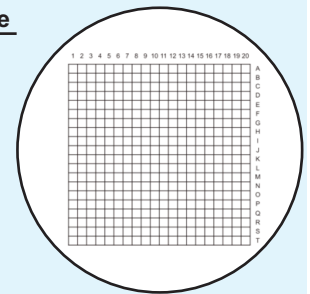

NE35

Useful for particle counting, particularly where reference is needed between workers, especially rectangular shapes, also for particle counting. Numbered 0 to 99.

Pattern	Description	Diameter	Order Code
NE35	Numbered grid 10mm x 10mm. 1mm indexed squares.	16mm	01B16221
		19mm	01B19221
		20.4mm	01B20.4221
		21mm	01B21221
		23mm	01B23221
		24mm	01B24221
		24.5mm	01B24.5221
		25mm	01B25221
		26mm	01B26221
		27mm	01B27221
		Special	01BSP221

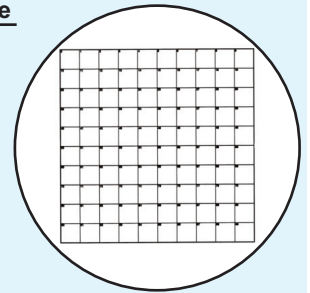

Chessboard Squares

NE15

The dark squares are translucent. Used as an alternative to simple grids for area of specimen determination and particle counting. Alternate light and dark squares help to reduce eyestrain. Semi coating gives approximately 50% light transmission.

Pattern	Description	Diameter	Order Code
NE15	Chessboard (net) 2.0mm squares.	16mm	01B16211
		19mm	01B19211
		20.4mm	01B20.4211
		21mm	01B21211
		23mm	01B23211
		24mm	01B24211
		24.5mm	01B24.5211
		25mm	01B25211
		26mm	01B26211
		27mm	01B27211
		Special	01BSP211

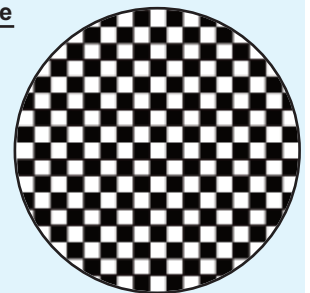

Squares and Grids

NE38

Combines three areas in one for convenience, giving area ratios A:B of 1:3 and B:C of 1:2.

Pattern	Description	Diameter	Order Code
NE38	Squares 10mm, 7mm & 4mm.	16mm	01B16222
		19mm	01B19222
		20.4mm	01B20.4222
		21mm	01B21222
		23mm	01B23222
		24mm	01B24222
		24.5mm	01B24.5222
		25mm	01B25222
		26mm	01B26222
		27mm	01B27222
		Special	01BSP222

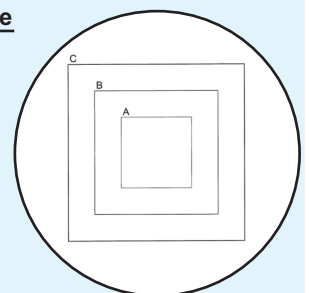

Miller Squares

NE57

The ratio of large to small square is 9:1. Originally designed for haematology, they can be utilised for rapid counting of any evenly spread field of particles.

References: American Journal of Clinical Pathology Vol. 20, 1950, page 1079. "Time Saving Device For Counting Reticulocyte." G.Brescher and Schneiderman.

Practical Haematology-J.D.Dacy. Published by J.A.Churchill. 2nd Edition 1956

Pattern	Description	Diameter	Order Code
NE57	Miller 7 x 7 mm grid.	16mm	01B16232
		19mm	01B19232
		20.4mm	01B20.4232
		21mm	01B21232
		23mm	01B23232
		24mm	01B24232
		24.5mm	01B24.5232
		25mm	01B25232
		26mm	01B26232
		27mm	01B27232
		Special	01BSP232

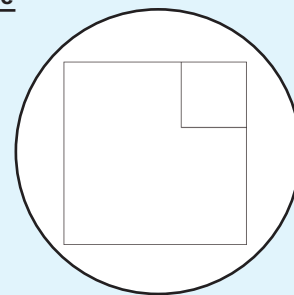

Whipple Grid

NE29

Originally designed for water particle analysis, but may be used for other aspects of particle counting. Grid shown: Ratio of full square to smallest is 50:1. Area is 2500:1

Reference: Microscopy of Drinking Water.

Please note the NE29 is also available with a 10mm x 10mm grid to special order.

Pattern	Description	Diameter	Order Code
NE29	Whipple grid 100 squares in 7mm. area.	16mm	01B16218
		19mm	01B19218
		20.4mm	01B20.4218
		21mm	01B21218
		23mm	01B23218
		24mm	01B24218
		24.5mm	01B24.5218
		25mm	01B25218
		26mm	01B26218
		27mm	01B27218
		Special	01BSP218

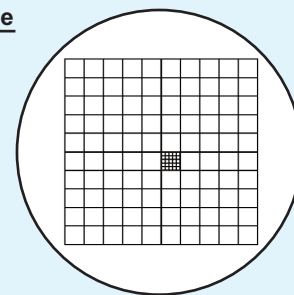

Circle Gauges and Protractors

Concentric Circles

NE42, NE43, NE44, NE47

Can be used for two-way measurement when calibrated as a micrometer.

Pattern	Description	Diameter	Order Code
NE42	Concentric circles 0.25mm – 2.5mm diameter. 10 circles.	16mm	01B16224
		19mm	01B19224
		20.4mm	01B20.4224
		21mm	01B21224
		23mm	01B23224
		24mm	01B24224
		24.5mm	01B24.5224
		25mm	01B25224
		26mm	01B26224
		27mm	01B27224
		Special	01BSP224

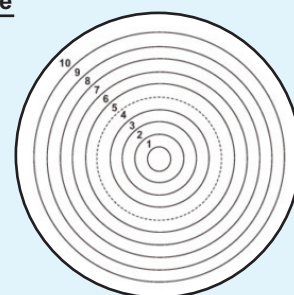

Pattern	Description	Diameter	Order Code
NE43	Concentric circles 0.5mm – 5mm diameter. 10 circles.	16mm	01B16225
		19mm	01B19225
		20.4mm	01B20.4225
		21mm	01B21225
		23mm	01B23225
		24mm	01B24225
		24.5mm	01B24.5225
		25mm	01B25225
		26mm	01B26225
		27mm	01B27225
		Special	01BSP225

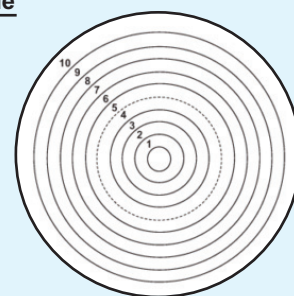

Concentric Circles + Cross Scales

NE44, NE47, NE48

Similar to concentric circles, but with graduated cross hairs.

Pattern	Description	Diameter	Order Code
NE44	Concentric circles 1mm – 10mm diameter. 10 circles.	16mm	01B16226
		19mm	01B19226
		20.4mm	01B20.4226
		21mm	01B21226
		23mm	01B23226
		24mm	01B24226
		24.5mm	01B24.5226
		25mm	01B25226
		26mm	01B26226
		27mm	01B27226
	Special	01BSP226	

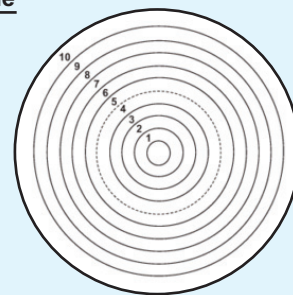

Pattern	Description	Diameter	Order Code
NE47	Concentric circles 2mm – 20mm diameter. 10 circles.	21mm	01B21228
		23mm	01B23228
		24mm	01B24228
		24.5mm	01B24.5228
		25mm	01B25228
		26mm	01B26228
		27mm	01B27228
			Special

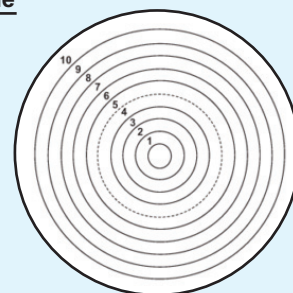

Pattern	Description	Diameter	Order Code
NE48	Concentric circles, 10 circles 1mm -10mm, with graduated cross hairs	16mm	01B16242
		19mm	01B19242
		20.4mm	01B20.4242
		21mm	01B21242
		23mm	01B23242
		24mm	01B24242
		24.5mm	01B24.5242
		25mm	01B25242
		26mm	01B26242
		27mm	01B27242
			Special

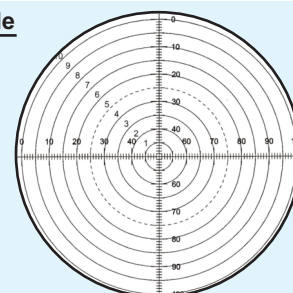

Concentric Circles

NE22

This design leaves the circles clear of obstruction. In addition the intermediate lines are broken to improve ease of reading.

Pattern	Description	Diameter	Order Code
NE22	Concentric circles 0.5mm - 12mm diameter, 24 circles.	16mm	01B16215
		19mm	01B19215
		20.4mm	01B20.4215
		21mm	01B21215
		23mm	01B23215
		24mm	01B24215
		24.5mm	01B24.5215
		25mm	01B25215
		26mm	01B26215
		27mm	01B27215
			Special

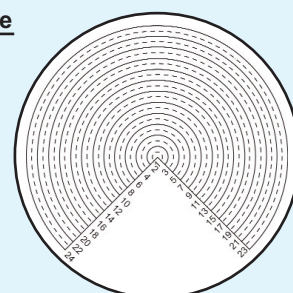

Gauge Pairs

NE19

Gauge pairs occupying a field of view of 10mm. Each gauge is proportional to its adjacent number. Approximate size of smallest pair = 0.1mm.

Pattern	Description	Diameter	Order Code
NE19	Gauge pairs	16mm	01B16241
		19mm	01B19241
		20.4mm	01B20.4241
		21mm	01B21241
		23mm	01B23241
		24mm	01B24241
		24.5mm	01B24.5241
		25mm	01B25241
		26mm	01B26241
		27mm	01B27241
			Special

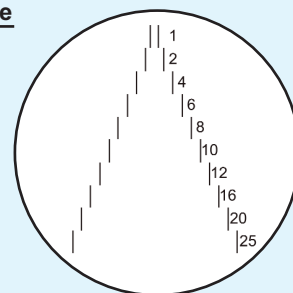

Protractors

Placed in the eyepiece, these are used in the same manner as ordinary protractors.

Half Protractor

NE25

Pattern	Description	Diameter	Order Code
NE25	Half protractor scale 10mm diameter divided in degrees.	16mm	01B16216
		19mm	01B19216
		20.4mm	01B20.4216
		21mm	01B21216
		23mm	01B23216
		24mm	01B24216
		24.5mm	01B24.5216
		25mm	01B25216
		26mm	01B26216
		27mm	01B27216
	Special	01BSP216	

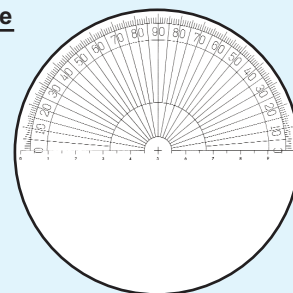

Full Protractor

NE45

Pattern	Description	Diameter	Order Code
NE45	Full protractor scale 10mm diameter divided in degrees.	16mm	01B16227
		19mm	01B19227
		20.4mm	01B20.4227
		21mm	01B21227
		23mm	01B23227
		24mm	01B24227
		24.5mm	01B24.5227
		25mm	01B25227
		26mm	01B26227
		27mm	01B27227
	Special	01BSP227	

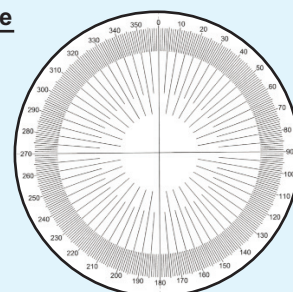

Particle Sizing and Distribution

The use of the eyepiece reticles shown in this section make it possible to analyse specimens containing particles as an alternative, or in addition to, sieving. Reticles for particle size analysis are particularly popular when there are only limited quantities of particles or where particles are smaller than 50 micron diameter. Typical substances analysed are sand grains, soil particles, plant seeds, fertilizers, abrasives, liquid droplets, pigments, pulverised coal, silica, fibres and fine dust.

The basic principle employed is to compare particles to the globes and circles of varying sizes that appear on the reticle – dark particles being compared to solid globes, and light or transparent ones to the circles. Naturally the procedure varies with the reticle concerned, more information about which is given alongside each reticle description.

Please note that for calibration the circles and globes will represent particles smaller in diameter by the magnification of the objective.

Patterson Globes and Circles

NG1

The reticle consists of a central rectangle, sub-divided into nine smaller rectangles with a number of increasing circles outside the top and bottom horizontal edges. The marked figures are the diameters of the circles in units. 250 units represent the horizontal length of the large rectangle. Rectangle size is 4.5mm x 2.025mm. Circle sizes in microns are nominally 450, 360, 270, 225, 180, 145, 110, 74, 37 and 18.

Pattern	Description	Diameter	Order Code
NG1	Patterson globes/circles.	16mm	01B16250
		19mm	01B19250
		20.4mm	01B20.4250
		21mm	01B21250
		23mm	01B23250
		24mm	01B24250
		24.5mm	01B24.5250
		25mm	01B25250
		26mm	01B26250
		27mm	01B27250
	Special	01BSP250	

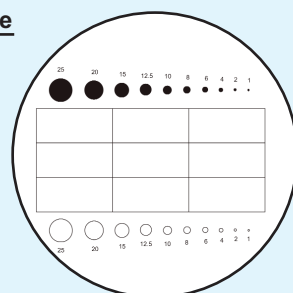

Reference: H.S.Patterson and W.Cawood. Transactions of the Faraday Society, Vol. 32 Feb 1936.

“The Determination of Size Distribution in Smokes.” Pp. 1084-1088.

Drawings not to scale

Porton

NG2

The circle areas of the Porton reticles increase with Root 2 progression as do the divisions on the right hand side of the rectangle. These divisions are numbered for convenience. Rectangle size is 4.5mm x 2.025mm. The specimen is racked on the mechanical stage of the microscope and traverses are taken right across the deposit sizing all the particles encountered.

Pattern	Description	Diameter	Order Code
NG2	Original Porton globes/circle	16mm	01B16251
		19mm	01B19251
		20.4mm	01B20.4251
		21mm	01B21251
		23mm	01B23251
		24mm	01B24251
		24.5mm	01B24.5251
		25mm	01B25251
		26mm	01B26251
		27mm	01B27251
		Special	01BSP251

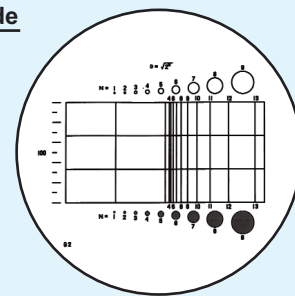

Reference: K.R.May, Journal of Scientific Instruments Vol. 22 Oct 1945. "The Cascade Impactor." An instrument for sampling coarse aerosols.

New Porton

NG12

The NG12 is particularly useful since the array of globes and circles are conveniently close to where the particles pass. At the end of each band of the sample the mechanical stage is traversed vertically to take in the next band until the whole sample has been covered.

Pattern	Description	Diameter	Order Code
NG12	Modified Porton pattern globes/circle.	16mm	01B16253
		19mm	01B19253
		20.4mm	01B20.4253
		21mm	01B21253
		23mm	01B23253
		24mm	01B24253
		24.5mm	01B24.5253
		25mm	01B25253
		26mm	01B26253
		27mm	01B27253
		Special	01BSP253

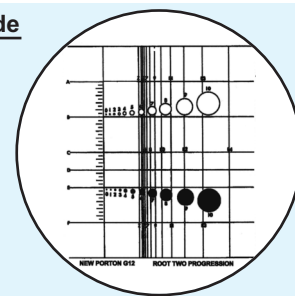

Reference: K.R.May, Journal of Scientific Instruments Vol. 42 1965. "A New Graticule for Particle Counting and Sizing." Pp 500-501.

British Standard Reticle

NG10

In this reticle the circle areas double progressively, hence the diameters alter by Root 2, so that the size classes can form a continuation of the standard series of sieves for particle sizing. Each particle is assigned to a size class defined by two adjacent circles which represent the size limits of that class. Thus the distribution of size is obtained in terms of the diameter of circles having the same projected area as the particles. This method will cover particles in the range 150 micron to 0.38 micron. The size distributions with respect to their number and weight are determined separately. Final results are calculated as cumulative percents. Actual size of circles and globes are nominally 560 μ , 400 μ , 280 μ , 200 μ , 149 μ , 100 μ and 70 μ . Circle 1 is defined as 1 unit. Originally designed by the National Coal Board for use in coal mining. References: BS3625/BS3260

Pattern	Description	Diameter	Order Code
NG10	British standard (BS3625/BS3260) globes & circles.	16mm	01B16252
		19mm	01B19252
		20.4mm	01B20.4252
		21mm	01B21252
		23mm	01B23252
		24mm	01B24252
		24.5mm	01B24.5252
		25mm	01B25252
		26mm	01B26252
27mm	01B27252		
Special	01BSP252		

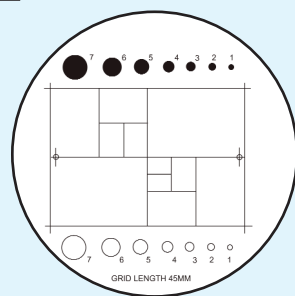

Fairs

NG5

Designed to extend the sizing range of globe and circle reticles. Example: Used in conjunction with NG2 the overall size range = 128:1. The circles increase by root 2. Note that both reticles would have to be used with the same microscope, eyepiece and objective.

Reference: G.L Fairs Chem Ind. 1943 Vol. 62. Pp 374-378. "The Use Of The Microscope In Particle Size Analysis."

Pattern	Description	Diameter	Order Code
NG5	Fairs.	16mm	01A16077
		19mm	01A19077
		20.4mm	01A20.4077
		21mm	01A21077
		23mm	01A23077
		24mm	01A24077
		24.5mm	01A24.5077
		25mm	01A25077
		26mm	01A26077
		27mm	01A27077
		Special	01ASP077

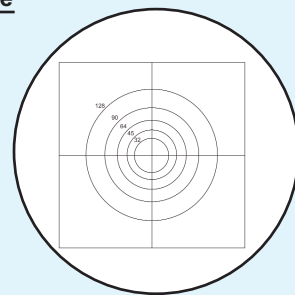

Asbestos Fibre Analysis - Walton & Beckett Reticle

G22,G24

Calibration factors are required for each of these reticles, see note below. The Walton and Beckett

reticle is used for counting fibrous dust (e.g. asbestos or glass fibres) and is particularly useful where the majority of fibres to be counted are shorter than 5 micron. The circle is divided into four by two diametrical lines scaled in units of 5 and 3 microns

respectively. 3 and 5 microns are the critical measurements of fibre lengths and diameter used in fibre counting.

Unlike the usual globes of other particle reticles the Walton and Beckett has a series of shapes to compare objects with. These shapes have been designed for comparison with fibres, especially since they incorporate an aspect ratio of 3:1 or 5:1 essential for such analysis.

Reference: W.H.Walton and S.T. Beckett. Occupational Hygiene. Vol. 20 pp 19-23. "A Microscope Eyepiece For The Evaluation of Fibrous Dusts."

Pattern	Description	Diameter	Order Code
G22	Walton & Beckett for asbestos. 3:1 ratio.	16mm	01A16062
		19mm	01A19062
		20.4mm	01A20.4062
		21mm	01A21062
		23mm	01A23062
		24mm	01A24062
		24.5mm	01A24.5062
		25mm	01A25062
		26mm	01A26062
		27mm	01A27062
		Special	01ASP062

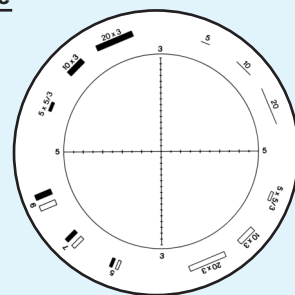

Pattern	Description	Diameter	Order Code
G24	Walton & Beckett for asbestos. 5:1 ratio.	16mm	01A16063
		19mm	01A19063
		20.4mm	01A20.4063
		21mm	01A21063
		23mm	01A23063
		24mm	01A24063
		24.5mm	01A24.5063
		25mm	01A25063
		26mm	01A26063
		27mm	01A27063
		Special	01ASP063

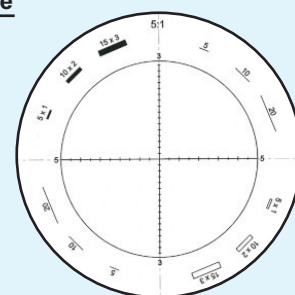

G25

Based on the G22, the G25 is produced to a new design by the Institute of Occupational Health.

Pattern	Description	Diameter	Order Code
G25	Walton & Beckett for asbestos (1996).	16mm	01A16085
		19mm	01A19085
		20.4mm	01A20.4085
		21mm	01A21085
		23mm	01A23085
		24mm	01A24085
		24.5mm	01A24.5085
		25mm	01A25085
		26mm	01A26085
		27mm	01A27085
		Special	01ASP085

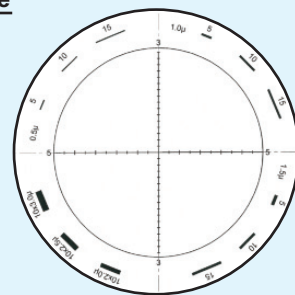

IMPORTANT NOTE. The circle on these Walton & Beckett reticles must represent 100 microns at the stage and each one must be manufactured to suit the individual instrument. Therefore, details should be provided with your order of :- Calibration factor, if known or Objective magnification, eyepiece magnification, diameter of reticle disc required, microscope make and model.

All Walton & Beckett reticles are normally used with 40x objectives giving a calibration factor of 4. In some microscopes there is also an additional 1.25x magnification to give a total objective magnification of 50x - these will have a calibration factor of 5. All standard Walton & Beckett reticles are supplied with a calibration factor of 4. Other calibration factors are made to special order. These reticles will require a calibrated stage micrometer to verify the sizes - See S12 or PS12 in Calibration Standards Brochure. For phase contrast verification see also S84.

Drawings not to scale

SPECIALIST DESIGNS

Spray Droplet Sizing Reticle (Matthews)

NG30

For size and distribution assessments of aerosol droplets.

Used with 4x objective for direct measurements of droplets groups of 50, 100, 200, 400 microns diameter.

W.H.O.

(Details on request) and G.A. Matthews. Imperial College.

Pattern	Description	Diameter	Order Code
NG30	Matthews spray droplet.	16mm	01B16261
		19mm	01B19261
		20.4mm	01B20.4261
		21mm	01B21261
		23mm	01B23261
		24mm	01B24261
		24.5mm	01B24.5261
		25mm	01B25261
		26mm	01B26261
		27mm	01B27261
		Special	01BSP261

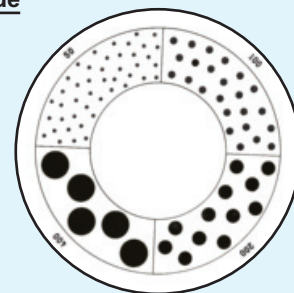

Thompson

G23

For counting particles in any of three areas of known size. The graticule is calibrated in the same manner as a normal eyepiece scale. The result is then used to calculate the area of any square.

Pattern	Description	Diameter	Order Code
G23	Thompson for dust analysis. 10mm, 7mm and 4mm squares with 10mm scale in 0.1mm divisions and cross lines	16mm	01A16056
		19mm	01A19056
		20.4mm	01A20.4056
		21mm	01A21056
		23mm	01A23056
		24mm	01A24056
		24.5mm	01A24.5056
		25mm	01A25056
		26mm	01A26056
		27mm	01A27056
		Special	01ASP056

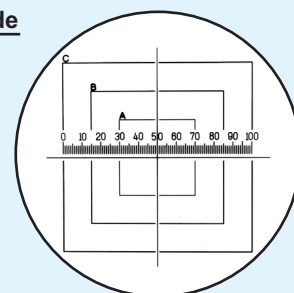

Chalkley Point Array

NG52

This is used to quickly determine the relationship of components to each other using random sampling. An example of its application is given by Curtis, where a researcher might want to see whether or not a certain drug affects the volume proportion of cell types in a given organ. With this reticle the proportion of points lying over the image of one type of component is statistically proportional to the area occupied by that component. The 25 points of the array are placed over the field of view at random, so that a comparison can be made between the number of points touching the one type of component, with the number touching the other type of component in each viewing. A series of observations will yield an increasingly accurate ratio of the comparative incidence of each type of particle. Ref. A.S.C.Curtis. Medical and Biological Illustration, Vol. 10. pp 261- 266. "Area and Volume Measurements by Random Sampling Methods"

Pattern	Description	Diameter	Order Code
NG52	Chalkley point array.	16mm	01B16257
		19mm	01B19257
		20.4mm	01B20.4257
		21mm	01B21257
		23mm	01B23257
		24mm	01B24257
		24.5mm	01B24.5257
		25mm	01B25257
		26mm	01B26257
		27mm	01B27257
		Special	01BSP257

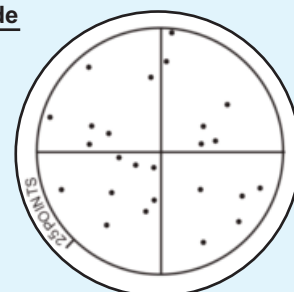

Pharmaceutical PSA Pattern

G57

This reticle was designed for the pharmaceutical industry. However, it is also useful where particle size considerations are restricted to 10 μ and 25 μ . Dots and circles give quick references for these two sizes. In addition a scale is incorporated.

The microscope must be calibrated when ordering this reticle, such that the circle must equate to 1mm on the microscope stage.

Reference: The United States Pharmaceutical Conventions Inc. Pharmaceutical Forum Vol.19 No.6.

This reticle is normally used with a 10x objective: calibration factor of 1. If a different objective magnification is used then a calibration factor will be needed to allow us to make it to the correct size. S8 and PS8 are recommended stage micrometers for use with this reticle.

Pattern	Description	Diameter	Order Code
G57	Pharmaceutical PSA Pattern. IMA Reticle (USP 788) Actual dot sizes are 100 μ m and 250 μ m	19mm	01A19076
		20.4mm	01A20.4076
		21mm	01A21076
		23mm	01A23076
		24mm	01A24076
		24.5mm	01A24.5076
		25mm	01A25076
		26mm	01A26076
		27mm	01A27076
		Special	01ASP076

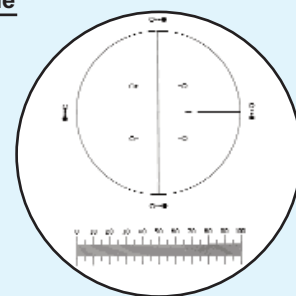

Counting Pattern

NG14

Simple counting for geological and soil analysis.

Reference: L.G.Briarty. "Stereology : Methods for Quantitative Light and Electron Microscopy." Sci. Prog. Oxf. 1975 62; 1-32

Pattern	Description	Diameter	Order Code
NG14	Counting pattern for soil analysis. 10mm square.	16mm	01B16254
		19mm	01B19254
		20.4mm	01B20.4254
		21mm	01B21254
		23mm	01B23254
		24mm	01B24254
		24.5mm	01B24.5254
		25mm	01B25254
		26mm	01B26254
		27mm	01B27254
Special	01BSP254		

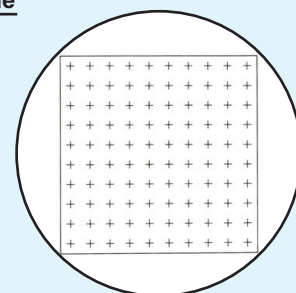

Lennox Grain Analysis

NG21

Pattern	Description	Diameter	Order Code
NG21	Lennox for grain analysis.	16mm	01B16255
		19mm	01B19255
		20.4mm	01B20.4255
		21mm	01B21255
		23mm	01B23255
		24mm	01B24255
		24.5mm	01B24.5255
		25mm	01B25255
		26mm	01B26255
		27mm	01B27255
Special	01BSP255		

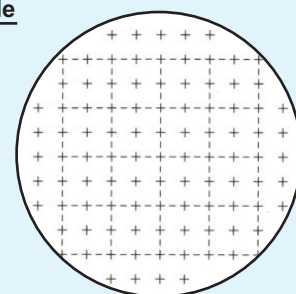

Kotter

G48

Reference: I.S.O. 7404-4: 1988 (E). Methods for Analysis of Bituminous Coal and Anthracite. Part 4 and Methods of Determining Microlithotype Composition.

Normally used with 20x objective = calibration factor of 1. For use with 40x objective specify calibration factor of 2, for 50x specify 2.5. For other objective magnifications the reticle will need to be custom made.

Pattern	Description	Diameter	Order Code
G48	Kotter pattern. Note: This pattern requires a calibration factor.	16mm	01A16072
		19mm	01A19072
		20.4mm	01A20.4072
		21mm	01A21072
		23mm	01A23072
		24mm	01A24072
		24.5mm	01A24.5072
		25mm	01A25072
		26mm	01A26072
		27mm	01A27072
Special	01ASP072		

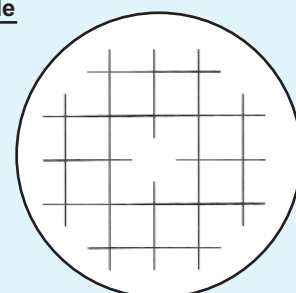

Zeiss Integrating Eyepiece Disc 1 or Henning Reseau Pattern 25 points

G49

Reference: Zeiss Werkzeitschrift.

Pattern	Description	Diameter	Order Code
G49	Henning Reseau pattern. (Zeiss integrating disc 1)	16mm	01A16073
		19mm	01A19073
		20.4mm	01A20.4073
		21mm	01A21073
		23mm	01A23073
		24mm	01A24073
		24.5mm	01A24.5073
		25mm	01A25073
		26mm	01A26073
		27mm	01A27073
		Special	01ASP073

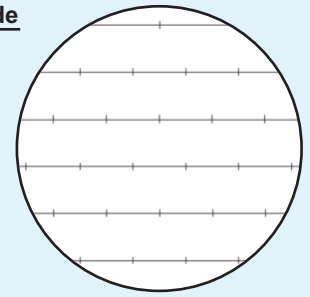

Part scale shown

Zeiss Integrating Eyepiece Disc 100

G47

Similar to G49 but extended to 100 points, which are indexed.

Pattern	Description	Diameter	Order Code
G47	Zeiss Integrating eyepiece disc.	16mm	01A16090
		19mm	01A19090
		20.4mm	01A20.4090
		21mm	01A21090
		23mm	01A23090
		24mm	01A24090
		24.5mm	01A24.5090
		25mm	01A25090
		26mm	01A26090
		27mm	01A27090
		Special	01ASP090

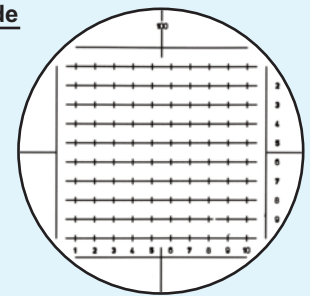

Integrating Eyepiece

G50

Pattern	Description	Diameter	Order Code
G50	Integrating eyepiece (simplified).	19mm	01A19075
		20.4mm	01A20.4075
		21mm	01A21075
		23mm	01A23075
		24mm	01A24075
		24.5mm	01A24.5075
		25mm	01A25075
		26mm	01A26075
		27mm	01A27075
		Special	01ASP075

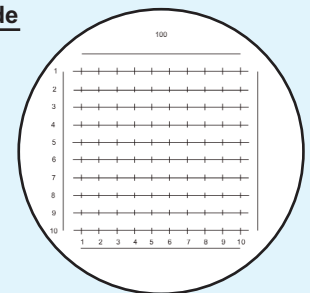

Stereology

In its simplest form, stereology is the science where information about a three dimensional object is obtained from only a two-dimensional section of that structure.

Measurements are usually made with these reticles in the following manner:-

1. An adequate representation of sections of a specimen is obtained.
2. The reticle is superimposed upon the specimen (or micrograph/projected image of the section).
3. Finally, the interaction between the superimposed reticle and the test sections are recorded.

An overall introduction is given by: L.G.Briarty. "Stereology : Methods for Quantitative Light and Electron Microscopy." Sci. Prog. Oxf. 1975 62; 1-32

The Mertz Reticle (36 point)

NGM1

Used to estimate the three dimensional surface areas or the surface density of a component in a given volume, when the component does not have a random orientation. It comprises a test system with parallel curved lines used for measuring the intersection of points. Reference: W.A.Mertz . " Mikroskopie" Vol. 22 1967 pp 132-142.

Pattern	Description	Diameter	Order Code
NGM1	Mertz for stereology.	16mm	01B16258
		19mm	01B19258
		20.4mm	01B20.4258
		21mm	01B21258
		23mm	01B23258
		24mm	01B24258
		24.5mm	01B24.5258
		25mm	01B25258
		26mm	01B26258
		27mm	01B27258
		Special	01BSP258

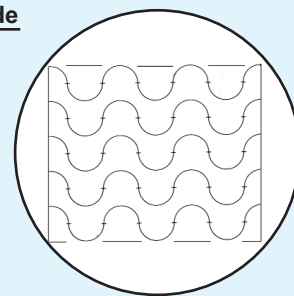

Weibel 1

NGW1

15 lines of equal length connecting the verticals of a regular hexagonal point network. Reference: E.R.Weibel Lab. Invest. Vol. 22 pp131-152. Principles and Methods for the Morphometric Study of the Lung and Other Organs.

Pattern	Description	Diameter	Order Code
NGW1	Weibel Type 1 for stereology.	16mm	01B16259
		19mm	01B19259
		20.4mm	01B20.4259
		21mm	01B21259
		23mm	01B23259
		24mm	01B24259
		24.5mm	01B24.5259
		25mm	01B25259
		26mm	01B26259
		27mm	01B27259
		Special	01BSP259

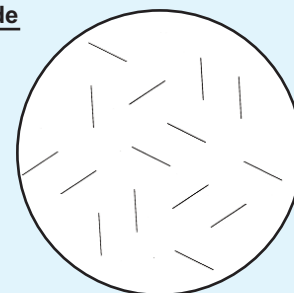

Weibel 2

NGW2

Used when making a surface to volume ratio of a structure per mass unit. This reticle consists of a number of short lines with interruptions as long as the lines. Basically, the number of intersections falling over the short lines are counted and the number of endpoints falling on the end of the structure are determined.

Pattern	Description	Diameter	Order Code
NGW2	Weibel Type 2 for stereology.	16mm	01B16260
		19mm	01B19260
		20.4mm	01B20.4260
		21mm	01B21260
		23mm	01B23260
		24mm	01B249260
		24.5mm	01B24.5260
		25mm	01B25260
		26mm	01B26260
		27mm	01B27260
		Special	01BSP260

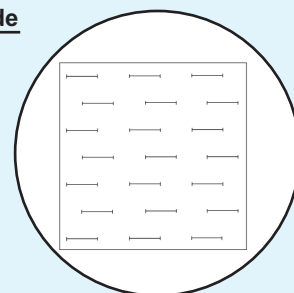

Reference: E.R.Weibel, Journal of Microscopy Vol. 95. Pp 373-378. Current Capabilities and Limitations of Available Stereological Techniques, point counting method.

Weibel 3

GW3

Reference: E.R.Weibel, G.S.Kistler & W.F.Scherle. 1966. J.Cell Biology. 30,23.

Pattern	Description	Diameter	Order Code
GW3	Weibel Type 3 for stereology.	16mm	01A16074
		19mm	01A19074
		20.4mm	01A20.4074
		21mm	01A21074
		23mm	01A23074
		24mm	01A24074
		24.5mm	01A24.5074
		25mm	01A25074
		26mm	01A26074
		27mm	01A27074
		Special	01ASP074

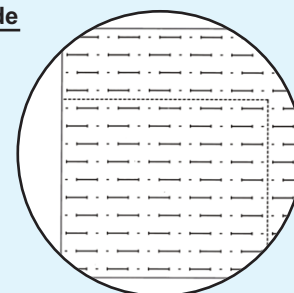

Part image shown

Standard pattern discs for metallurgical stereometric analysis of grain size in polished metal sections.

Grain Sizing Patterns EN10247/ISO4976

For the determination of non-metallic inclusion content of steel.

NG60 meets EN10247 & **NG61** meets ISO 4967. Both are scaled for use with 10x objective magnification.

Pattern Description	Diameter	Order Code
NG60 Grain Sizing reticle to EN10247	21mm	01B21265
	23mm	01B23265
	24mm	01B24265
	24.5mm	01B24.5265
	25mm	01B25265
	26mm	01B26265
	27mm	01B27265
	Special	01BSP265

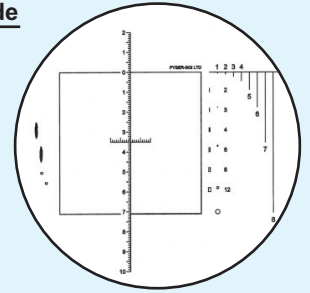

Pattern Description	Diameter	Order Code
NG61 Grain Sizing reticle to ISO4967. and JIS GO555	21mm	01B21266
	23mm	01B23266
	24mm	01B24266
	24.5mm	01B24.5266
	25mm	01B25266
	26mm	01B26266
	27mm	01B27266
	Special	01BSP266

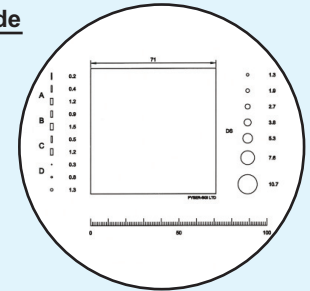

ASTM Austenite 1:1 Grain Sizing Disc

G41
Reference: VDEH 1510-61

Pattern Description	Diameter	Order Code
G41 ASTM Grain sizing austenite.	19mm	01A19064
	20.4mm	01A20.4064
	21mm	01A21064
	23mm	01A23064
	24mm	01A24064
	24.5mm	01A24.5064
	25mm	01A25064
	26mm	01A26064
	27mm	01A27064
	Special	01ASP064

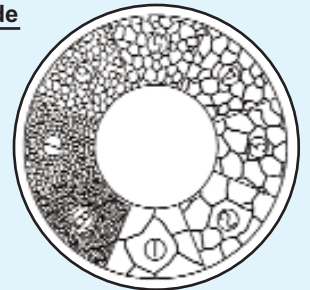

ASTM E112 Plate 1 Grain Sizing Disc

G42

Pattern Description	Diameter	Order Code
G42 Grain sizing E112.	19mm	01A19065
	20.4mm	01A20.4065
	21mm	01A21065
	23mm	01A23065
	24mm	01A24065
	24.5mm	01A24.5065
	25mm	01A25065
	26mm	01A26065
	27mm	01A27065
	Special	01ASP065



ASTM Carbide grain sizing chart

G43

Pattern	Description	Diameter	Order Code
G43	ASTM Grain sizing carbide.	19mm	01A19066
		20.4mm	01A20.4066
		21mm	01A21066
		23mm	01A23066
		24mm	01A24066
		24.5mm	01A24.5066
		25mm	01A25066
		26mm	01A26066
		27mm	01A27066
		Special	01ASP066



ASTM E45

G44

For some applications customers require the square to be 10mm x 10mm. Please state special on order for this version

Pattern	Description	Diameter	Order Code
G44	ASTM Grain sizing Root 2 sides. 7.1mm square, 10mm scale.	19mm	01A19086
		20.4mm	01A20.4086
		21mm	01A21086
		23mm	01A23086
		24mm	01A24086
		24.5mm	01A24.5086
		25mm	01A25086
		26mm	01A26086
		27mm	01A27086
		Special	01ASP086

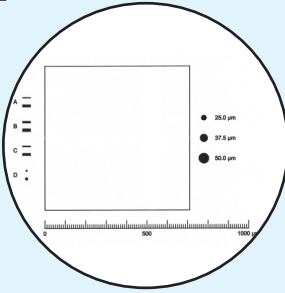

ASTM E19-46 Grain sizing disc

G45

Pattern	Description	Diameter	Order Code
G45	ASTM Grain sizing E19-46.	19mm	01A19067
		20.4mm	01A20.4067
		21mm	01A21067
		23mm	01A23067
		24mm	01A24067
		24.5mm	01A24.5067
		25mm	01A25067
		26mm	01A26067
		27mm	01A27067
		Special	01ASP067

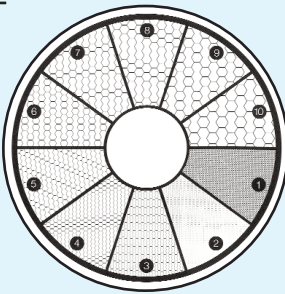

ASTM E19-46 Grain sizing disc root 2

G46

Pattern	Description	Diameter	Order Code
G46	ASTM Grain sizing E19-46. Root 2	19mm	01A19068
		20.4mm	01A20.4068
		21mm	01A21068
		23mm	01A23068
		24mm	01A24068
		24.5mm	01A24.5068
		25mm	01A25068
		26mm	01A26068
		27mm	01A27068
		Special	01ASP068

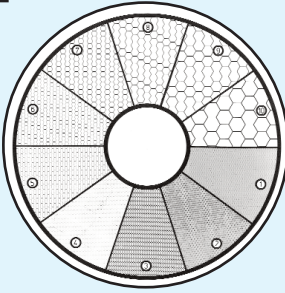

Circular grid ASTM 24 points

G54

Reference: ASTM E562

Pattern	Description	Diameter	Order Code
G54	ASTM 24 point circular grid.	19mm	01A19078
		20.4mm	01A20.4078
		21mm	01A21078
		23mm	01A23078
		24mm	01A24078
		24.5mm	01A24.5078
		25mm	01A25078
		26mm	01A26078
		27mm	01A27078
	Special	01ASP078	

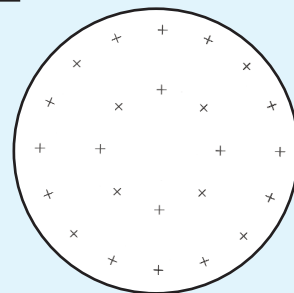

Square grid ASTM 25 points

G55

Reference: ASTM E562

Pattern	Description	Diameter	Order Code
G55	ASTM 25 point Square grid.	19mm	01A19079
		20.4mm	01A20.4079
		21mm	01A21079
		23mm	01A23079
		24mm	01A24079
		24.5mm	01A24.5079
		25mm	01A25079
		26mm	01A26079
		27mm	01A27079
	Special	01ASP079	

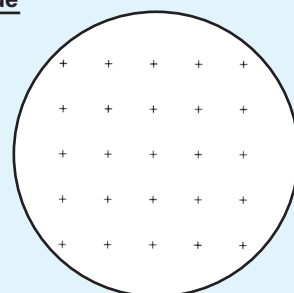



Graticules Optics Ltd

17-19 Morley Road, Tonbridge, Kent, TN9 1RN, UK

Tel +44 (0)1732 360 460

Email sales@graticulesoptics.com

www.graticulesoptics.com

